

66A2-MXXXXX 069 R01 (DIP)
66A2-MXXXXX 069 R02 (SMT)
固定公头系列

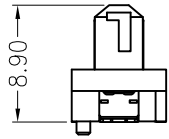

66A2-MXXXXX 089 R01 (DIP)
66A2-MXXXXX 089 R02 (SMT)
固定公头系列

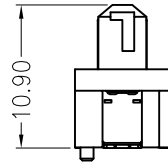

66A2-MXXXXX 109 R01 (DIP)
66A2-MXXXXX 109 R02 (SMT)
固定公头系列

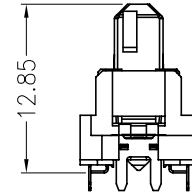

66A2L-MXXXXX 128 R51 (DIP)
浮动公头系列

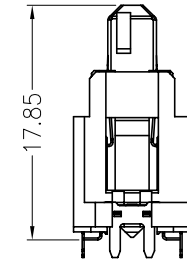

66A2L-MXXXXX 178 R51 (DIP)
浮动公头系列

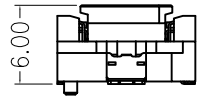

66A2-FXXXXX 060 R01 (DIP)
66A2-FXXXXX 060 R02 (SMT)
浮动母座系列

浮动系列
浮动范围：
X Y Z方向±0.5mm

公母都可浮动系列
浮动范围：
X Y Z方向±1.0mm

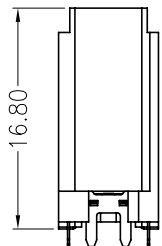

66A2L-FXXXXX 168 R51 (DIP)
固定母座系列

固定系列
无浮动

浮动系列
浮动范围：
X Y Z方向±0.5mm

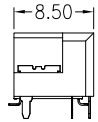

66A2R-FXXXXX 073 R01 (DIP)
卧式90° 固定母座系列

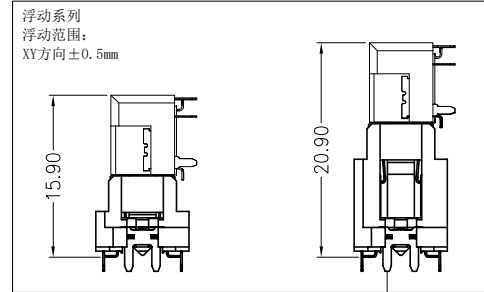
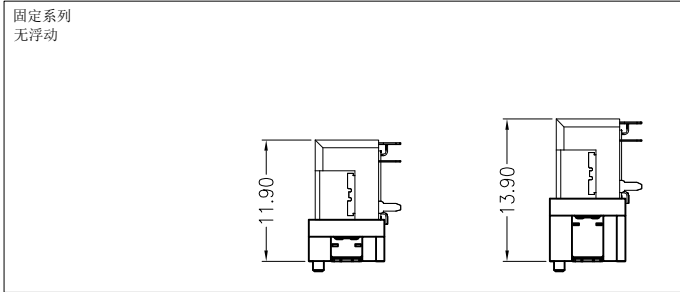

客户图

NOTES:

1. FINISH:
 - 1.1 HOUSING: LCP BLACK, UL94V-0.
 - 1.2 CONTACT: COPPER ALLOY, INTEGRAL NICKEL BASE 50u"MIN FLASH GOLD, CONTACT AND SOLDER FOOT AREA 3u"MIN
 - 1.3 GROUND: BRASS, INTEGRAL NICKEL BASE 50u"MIN; FLASH GOLD, CONTACT AND SOLDER FOOT AREA 3u"MIN
2. ELECTRICAL:
 - 2.1 RATED VOLTAGE: SIGNAL PIN AC 50 V.
POWER PIN AC 200 V.
 - 2.1 CURRENT RATING: SIGNAL PIN 0.5A.
POWER PIN 5.0A.
 - 2.2 DIELECTRIC WITHSTANDING VOLTAGE: SIGNAL PIN 150V AC/MINUTE.
POWER PIN 600V AC/MINUTE.
 - 2.3 CONTACT RESISTANCE: SIGNAL PIN 120mΩ MAX.
POWER PIN 80mΩ MAX.
 - 2.4 INSULATION RESISTANCE: SIGNAL PIN 100V DC/0.1S/100MΩ
POWER PIN 250V DC/0.1S/1000MΩ
3. SALT SPRAY TEST:
 - 3.1 CONCENTRATION IS 5%, THE TEMPERATURE IS 35±2°C,
TEST TIME 8H MIN, NO OXIDATION OR RUST
4. MAX PROCESSING TEMP: 265°C SECONDS 40S
5. OPERATION TEMPERATURE: -40°C TO +125°C
6. WARRANTY PERIOD: 6 MONTHS
7. ORDER INFORMATION:

66A2-F XXX XX 060 R 01

Pin 数码	端子电镀:	塑胶高度:	包装方式:
SEE TABLE	G0=Gold Flash(全金)	060=6.00mm("H1")	R=TAPE REEL
030=2x15PIN	G1=1u" Gold		
050=2x25PIN	G2=3u" Gold		
.....	G3=5u" Gold		
	G4=10u" Gold		
	G5=15u" Gold		
	G6=30u" Gold		

TABLE:

No. OF PIN	A	B	C	D
20=2x10PIN	19.50	5.80	4.50	9.30
30=2x15PIN	22.00	8.30	7.00	11.80
40=2x20PIN	24.50	10.80	9.50	14.30
50=2x25PIN	27.00	13.30	12.00	16.80
60=2x30PIN	29.50	15.80	14.50	19.30
80=2x40PIN	34.50	20.80	19.50	24.30
100=2x50PIN	39.50	25.80	24.50	29.30
120=2x60PIN	44.50	30.80	29.50	34.30

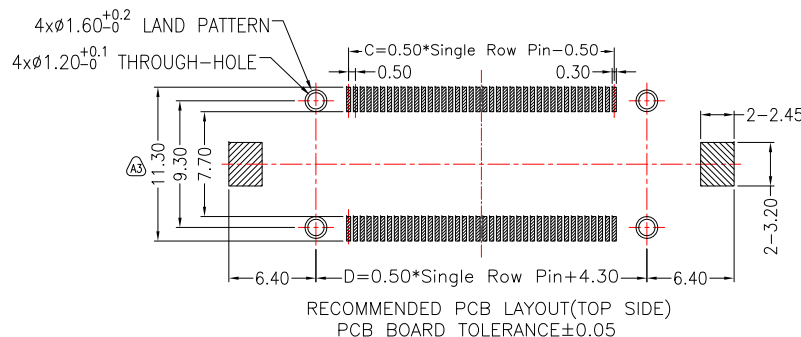
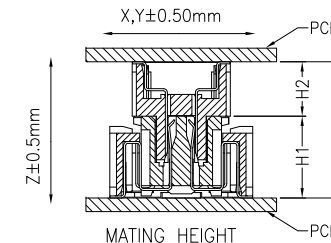
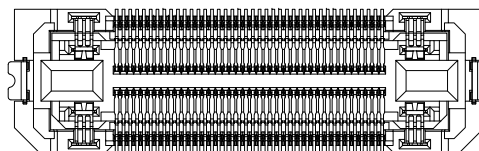
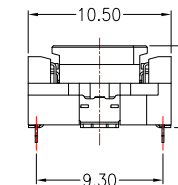
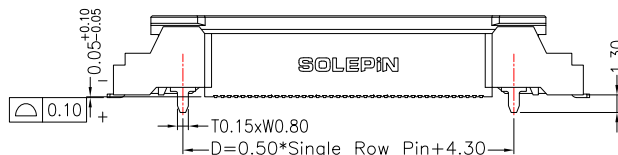
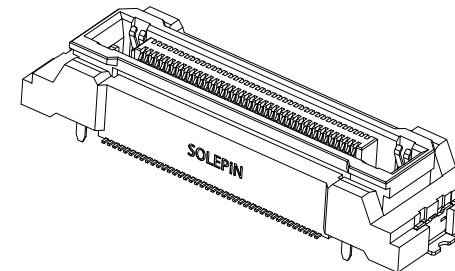
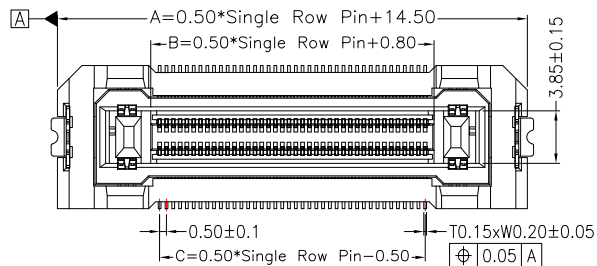

MATING HEIGHT	H1	H2	H3
8.0mm	6.00	2.00	8.00
10.0mm		4.00	10.00
12.0mm		6.00	12.00
14.0mm		8.00	14.00
19.0mm		13.00	19.00

REV	DATE	MODIFICATION DESCRIPTION	CHANGE	APPROVE	DIM.	TOL	UNIT	mm	SCALE	1:1	PROJ.	SIZE	A4	PART NO.	66A2-FXXXXX060R01
A3	2022.04.18	更新PCB LAYOUT	WLY		OPERATION		DRAW	WLY	2022.04.18	SOLEPIN 东莞市硕品电子有限公司 Professional connector manufacturer DONGGUAN SOLEPIN ELECTRONICS CO., LTD.					
A2	2021.10.09	接触电阻由80mΩ MAX. 修改为120mΩ MAX.	WLY		X.X ±0.40		DESIGN	Jensen	2022.04.18	SIZE					
A1	2021.05.28	焊盘长度加大0.2	WLY		X.XX ±0.25		CHECK	Jack	2022.04.18	PART NO.					
A0		NEW			X.XXX ±0.15		APPROVE	Andy	2022.04.18	TITLE:					
					Angle ±3°					0.50mm 浮动BTB 母座 直立式DIP TYPE					
					DIM.	TOL				DRAW NO.					
										SP-133					

客户图

NOTES:

1. FINISH:
 - 1.1 HOUSING: LCP BLACK, UL94V-0.
 - 1.2 CONTACT: COPPER ALLOY, INTEGRAL NICKEL BASE 50 μ MIN, CONTACT AND SOLDER FOOT AREA 3 μ MIN
 - 1.3 GROUND: BRASS, INTEGRAL NICKEL BASE 50 μ MIN, 80 μ MIN MATTE TIN PLATED OVER
2. ELECTRICAL:
 - 2.1 RATED VOLTAGE: SIGNAL PIN AC 50 V.
POWER PIN AC 200 V.
 - 2.2 CURRENT RATING: SIGNAL PIN 0.5A.
POWER PIN 5.0A.
 - 2.3 DIELECTRIC WITHSTANDING VOLTAGE: SIGNAL PIN 150V AC/MINUTE.
POWER PIN 600V AC/MINUTE.
 - 2.4 CONTACT RESISTANCE: SIGNAL PIN 120m Ω MAX.
POWER PIN 80m Ω MAX.
 - 2.5 INSULATION RESISTANCE: SIGNAL PIN 100V DC/0.1S/100M Ω
POWER PIN 250V DC/0.1S/1000M Ω
3. SALT SPRAY TEST:
 - 3.1 CONCENTRATION IS 5%, THE TEMPERATURE IS 35 \pm 2 $^{\circ}$ C, TEST TIME 24H MIN, NO OXIDATION OR RUST
4. Max Processing Temp: 265 $^{\circ}$ C Seconds 40S
5. OPERATION TEMPERATURE: -40 $^{\circ}$ C TO +125 $^{\circ}$ C.
6. WARRANTY PERIOD: 6 MONTHS
7. ORDER INFORMATION:

66A2-F XXX XX 060 R 02

Pin 数码	端子电镀:	塑胶高度:	包装方式:
SEE TABLE	G0=Gold Flash (全金)	060=6.00mm ("H1")	R=TAPE REEL
020=2x10PIN	G1=1 μ " Gold		
~	G2=3 μ " Gold		
120=2x60PIN	G3=5 μ " Gold		
	G4=10 μ " Gold		
	G5=15 μ " Gold		
	G6=30 μ " Gold		

TABLE:

No. OF PIN	A	B	C	D	E
020=2x10PIN	19.50	5.80	4.50	9.30	17.50
030=2x15PIN	22.00	8.30	7.00	11.80	20.00
040=2x20PIN	24.50	10.80	9.50	14.30	22.50
050=2x25PIN	27.00	13.30	12.00	16.80	25.00
060=2x30PIN	29.50	15.80	14.50	19.30	27.50
080=2x40PIN	34.50	20.80	19.50	24.30	32.50
100=2x50PIN	39.50	25.80	24.50	29.30	37.50
120=2x60PIN	44.50	30.80	29.50	34.30	42.50

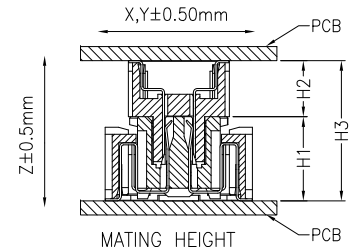
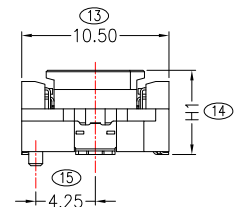
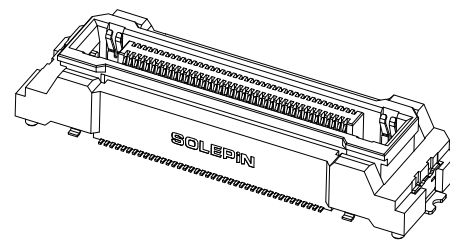
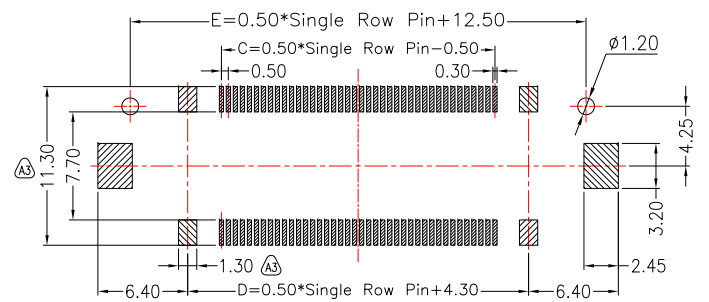
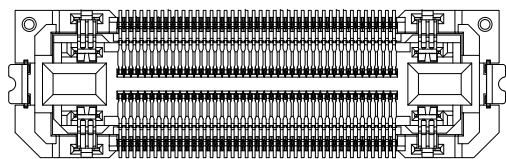
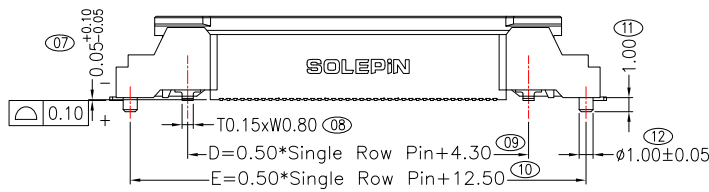
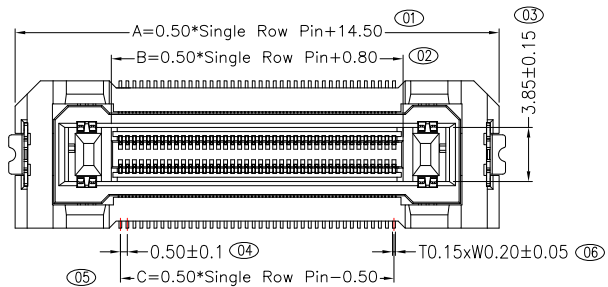

MATING HEIGHT	H1	H2	H3
8.0mm	6.00	2.00	8.00
10.0mm		4.00	10.00
12.0mm		6.00	12.00
14.0mm		8.00	14.00
19.0mm		13.00	19.00

REV	DATE	MODIFICATION DESCRIPTION	CHANGE	APPROVE	DIM.	TOL	UNIT	mm	SCALE	1:1	PROJ.	DRAW NO.	SP-135
A3	2022.04.18	更新PCB LAYOUT	WLY		OPERATION		DRAW	WLY	2022.04.18	SOLEPIN 东莞市硕品电子有限公司 Professional connector manufacturer DONGGUAN SOLEPIN ELECTRONICS CO., LTD.			
A2	2021.10.09	接触电阻由80m Ω MAX. 修改为120m Ω MAX.	WLY		X.X	\pm 0.40	DESIGN	Jensen	2022.04.18				
A1	2021.05.28	焊盘长度加大0.2	WLY		X.XX	\pm 0.25	CHECK	Jack	2022.04.18				
A0		NEW			X.XXX	\pm 0.15	APPROVE	Andy	2022.04.18				
					Angle	\pm 3 $^{\circ}$							

客户图

NOTES:

1. FINISH:
 - 1.1 HOUSING: LCP BLACK, UL94V-0.
 - 1.2 CONTACT: COPPER ALLOY, INTEGRAL NICKEL BASE 50u"MIN, CONTACT AND SOLDER FOOT AREA 3u"MIN
 - 1.3 GROUND: BRASS, INTEGRAL NICKEL BASE 50u"MIN, 80u" MIN MATTE TIN PLATED OVER
2. ELECTRICAL:
 - 2.1 RATED VOLTAGE: SIGNAL PIN AC 50 V.
POWER PIN AC 200 V.
 - 2.2 CURRENT RATING: SIGNAL PIN 0.5A.
POWER PIN 5.0A.
 - 2.3 DIELECTRIC WITHSTANDING VOLTAGE: SIGNAL PIN 150V AC/MINUTE.
POWER PIN 600V AC/MINUTE.
 - 2.4 CONTACT RESISTANCE: SIGNAL PIN 120mΩ MAX.
POWER PIN 80mΩ MAX.
 - 2.5 INSULATION RESISTANCE: SIGNAL PIN 100V DC/0.1S/100MΩ
POWER PIN 250V DC/0.1S/1000MΩ
3. SALT SPRAY TEST:
 - 3.1 CONCENTRATION IS 5%, THE TEMPERATURE IS 35±2°C,
TEST TIME 24H MIN, NO OXIDATION OR RUST
4. MAX PROCESSING TEMP: 265°C SECONDS 40S
5. OPERATION TEMPERATURE: -40°C TO +125°C.
6. WARRANTY PERIOD: 6 MONTHS
7. ORDER INFORMATION:

66A2L-F XXX XX 168 R 51

Pin 数码	端子电镀:	塑胶高度:	包装方式:
SEE TABLE	G0=Gold Flash(全金)	168=16.80mm	R=TAPE REEL
020=2x10PIN	G1=1u" Gold		
~	G2=3u" Gold		
120=2x60PIN	G3=5u" Gold		
	G4=10u" Gold		
	G5=15u" Gold		
	G6=30u" Gold		

TABLE:

No. OF PIN	A	B	C	D	E
020=2x10PIN	17.20	5.80	4.50	9.50	15.70
030=2x15PIN	19.70	8.30	7.00	12.00	18.20
040=2x20PIN	22.20	10.80	9.50	14.50	20.70
050=2x25PIN	24.70	13.30	12.00	17.00	23.20
060=2x30PIN	27.20	15.80	14.50	19.50	25.70
080=2x40PIN	32.20	20.80	19.50	24.50	30.70
100=2x50PIN	37.20	25.80	24.50	29.50	35.70
120=2x60PIN	42.20	30.80	29.50	34.50	40.70

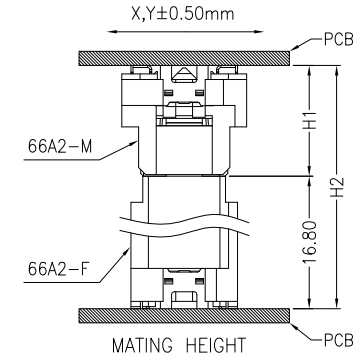
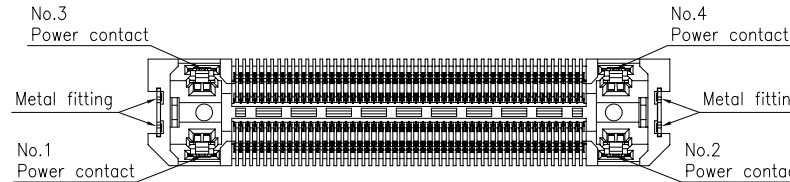
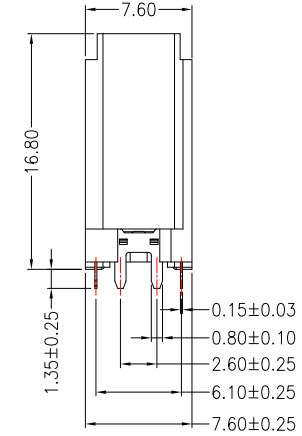
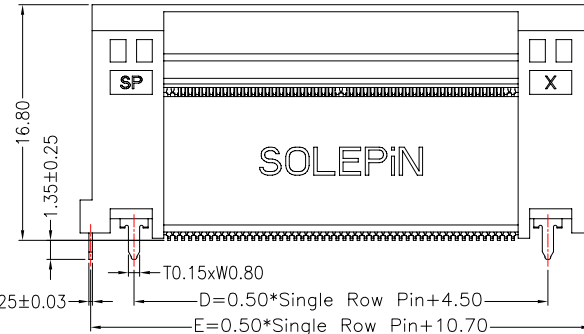
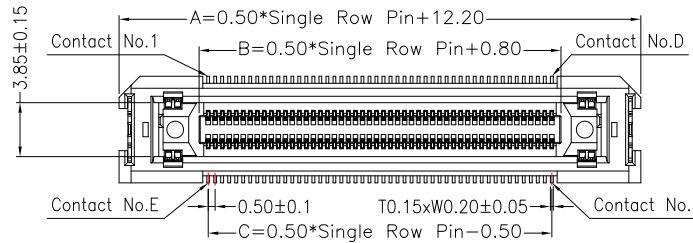

MATING HEIGHT	H1	H2
25.00mm	12.85	25.00
30.00mm	17.85	30.00

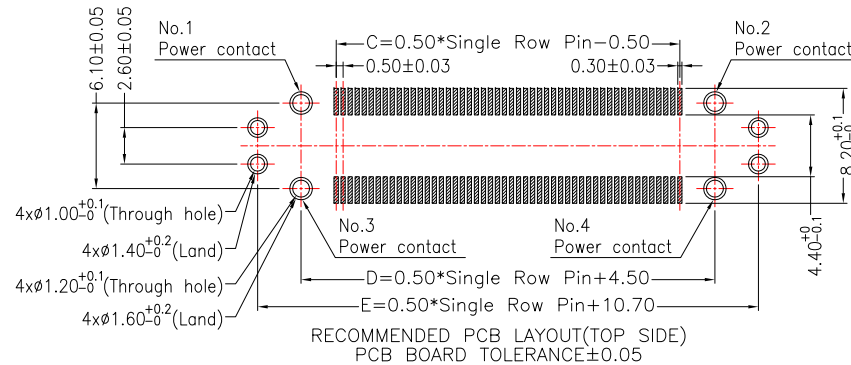

OPERATION		DRAW		WLY		2022.04.12		SOLEPIN 东莞市硕品电子有限公司 Professional connector manufacturer DONGGUAN SOLEPIN ELECTRONICS CO., LTD.	
X.X	±0.40	DESIGN	Jensen	2022.04.12		SIZE	A4		
X.XX	±0.25	CHECK	Jack	2022.04.12		SHEET	1/1	TITLE:	0.50mm 浮动BTB 母座(固定款) 直立式DIP TYPE
X.XXX	±0.15	APPROVE	Andy	2022.04.12		PROJ.	☞	DRAW NO.	SP-674
Angle	±3°	UNIT	mm	SCALE	1:1				
DIM.	TOL								

REV	DATE	MODIFICATION DESCRIPTION	CHANGE	APPROVE
AO		NEW		

客户图

NOTES:

- FINISH:
 - HOUSING: LCP BLACK,UL94V-0.
 - CONTACT: COPPER ALLOY, INTEGRAL NICKEL BASE 50u"MIN, CONTACT AND SOLDER FOOT AREA 3u"MIN
 - GROUND: BRASS, INTEGRAL NICKEL BASE 50u"MIN, 80u" MIN MATTE TIN PLATED OVER
- ELECTRICAL:
 - RATED VOLTAGE: SIGNAL PIN AC 50 V.
POWER PIN AC 200 V.
 - CURRENT RATING: SIGNAL PIN 0.5A.
POWER PIN 5.0A.
 - DIELECTRIC WITHSTANDING VOLTAGE: SIGNAL PIN 150V AC/MINUTE.
POWER PIN 600V AC/MINUTE.
 - CONTACT RESISTANCE: SIGNAL PIN 120mΩ MAX.
POWER PIN 80mΩ MAX.
 - INSULATION RESISTANCE: SIGNAL PIN 100V DC/0.1S/100MQ
POWER PIN 250V DC/0.1S/1000MQ
- SALT SPRAY TEST:
 - CONCENTRATION IS 5%, THE TEMPERATURE IS 35±2°C,
TEST TIME 24H MIN,NO OXIDATION OR RUST
- MAX PROCESSING TEMP:265°C SECONDS 40S
- OPERATION TEMPERATURE:-40°C TO +125°C.
- WARRANTY PERIOD: 6 MONTHS
- ORDER INFORMATION:

66A2L-M XXX XX XXX R 51

Pin 数码	端子电镀:	塑胶高度:	包装方式:
SEE TABLE	G0=Gold Flash	128=12.85mm("H1")	R=TAPE REEL
020=2*10PIN	G1=1u" Gold	178=17.85mm("H1")	
~	G2=3u" Gold		
120=2*60PIN	G3=5u" Gold		
	G4=10u" Gold		
	G5=15u" Gold		
	G6=30u" Gold		

TABLE:

No. OF PIN	A	B	C	D
020=2x10PIN	18.70	4.50	9.50	17.50
030=2x15PIN	21.20	7.00	12.00	20.00
040=2x20PIN	23.70	9.50	14.50	22.50
050=2x25PIN	26.20	12.00	17.00	25.00
060=2x30PIN	28.70	14.50	19.50	27.50
080=2x40PIN	33.70	19.50	24.50	32.50
100=2x50PIN	38.70	24.50	29.50	37.50
120=2x60PIN	43.70	29.50	34.50	42.50

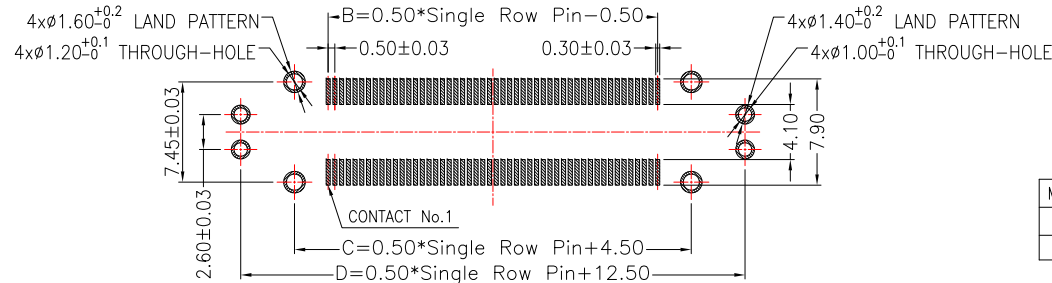
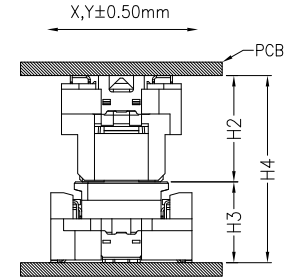
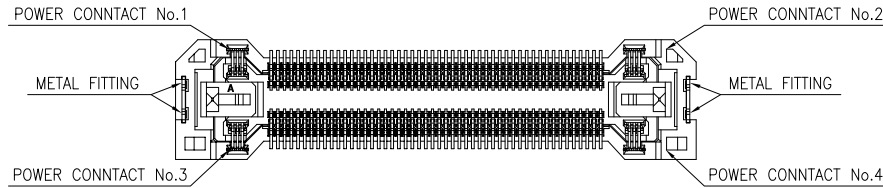
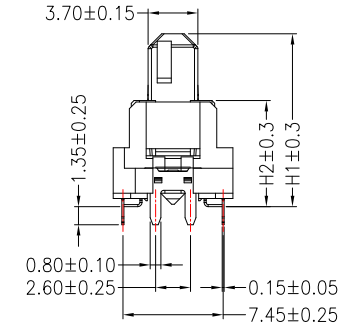
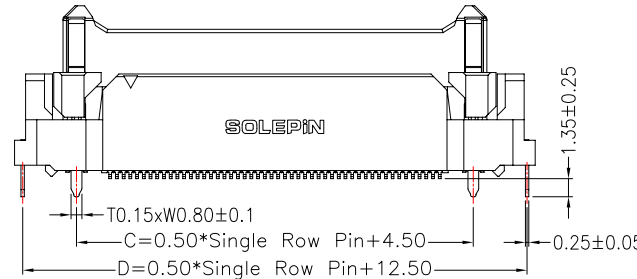
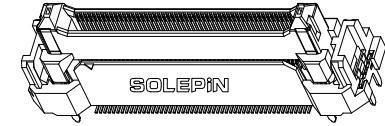
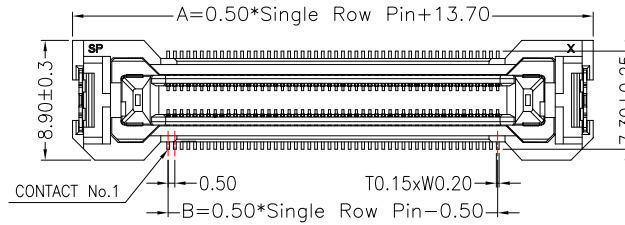

RECOMMENDED LAND PATTERN DIMENSION OF PCB
PCB THICKNESS:T=1.60mm

MATING HEIGHT	H1	H2	H3	H4
14.00mm	12.85	8.00	6.00	14.00
19.00mm	17.85	13.00		19.00

REV	DATE	MODIFICATION DESCRIPTION	CHANGE	APPROVE	OPERATION	DRAW	WLY	DATE	SOLEPIN 东莞市硕品电子有限公司 Professional connector manufacturer DONGGUAN SOLEPIN ELECTRONICS CO., LTD.				
					X.X ±0.40	DESIGN	Jensen	2022.03.10	SIZE	A4	PART NO.	66A2L-MXXXXXXXXR51	
					X.XX ±0.25	CHECK	Jack	2022.03.10	SHEET	1/1	TITLE:	0.50mm 浮动BTB 公头(浮动款) 直立式DIP TYPE	
AO		NEW			X.XXX ±0.15	APPROVE	Andy	2022.03.10	PROJ.	⊕	DRAW NO.	SP-134	
					Angle ±3°	UNIT	mm	SCALE	1:1				
					DIM. TOL								

客户图

NOTES:

- 1.FINISH:
 - 1.1 HOUSING: LCP BLACK,UL94V-0.
 - 1.2 CONTACT: COPPER ALLOY, INTEGRAL NICKEL BASE 50u"MIN, CONTACT AND SOLDER FOOT AREA 3u"MIN
 - 1.3 GROUND: BRASS, INTEGRAL NICKEL BASE 50u"MIN, 80u" MIN MATTE TIN PLATED OVER
2. ELECTRICAL:
 - 2.1 RATED VOLTAGE: SIGNAL PIN AC 50 V.
POWER PIN AC 200 V.
 - 2.2 CURRENT RATING: SIGNAL PIN 0.5A.
POWER PIN 5.0A.
 - 2.3 DIELECTRIC WITHSTANDING VOLTAGE: SIGNAL PIN 150V AC/MINUTE.
POWER PIN 600V AC/MINUTE.
 - 2.4 CONTACT RESISTANCE: SIGNAL PIN 120mΩ MAX.
POWER PIN 80mΩ MAX.
 - 2.5 INSULATION RESISTANCE: SIGNAL PIN 100V DC/0.1S/100MΩ
POWER PIN 250V DC/0.1S/1000MΩ
- 3.SALT SPRAY TEST:
 - 3.1 CONCENTRATION IS 5%, THE TEMPERATURE IS 35±2°C, TEST TIME 24H MIN,NO OXIDATION OR RUST
- 4.Max Processing Temp:265°C Seconds 40S
- 5.OPERATION TEMPERATURE:-40°C TO +125°C.
- 6.WARRANTY PERIOD: 6 MONTHS
- 7.ORDER INFORMATION:

66A2-M XXX XX 069 R 03

Pin数码	端子电镀:	塑胶高度:	包装方式:
020=2*10PIN	G0=Gold Flash(全金)	069=6.90mm	R=TAPE REEL
~	G1=1u" Gold		
120=2*60PIN	G2=3u" Gold		
	G3=5u" Gold		
	G4=10u" Gold		
	G5=15u" Gold		
	G6=30u" Gold		

TABLE:

No. OF PIN	A	B	C	D	E
020=2x10PIN	17.10	5.88	15.55	4.50	9.30
030=2x15PIN	19.60	8.38	18.05	7.00	11.80
040=2x20PIN	22.10	10.88	20.55	9.50	14.30
050=2x25PIN	24.60	13.38	23.05	12.00	16.80
060=2x30PIN	27.10	15.88	25.55	14.50	19.30
080=2x40PIN	32.10	20.88	30.55	19.50	24.30
100=2x50PIN	37.10	25.88	35.55	24.50	29.30
120=2x60PIN	42.10	30.88	40.55	29.50	34.30

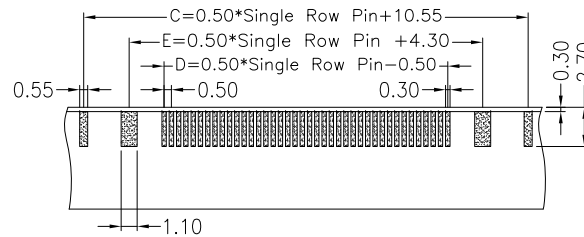
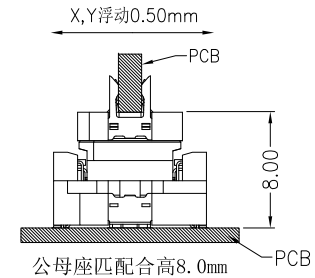
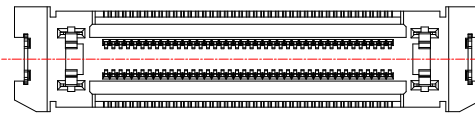
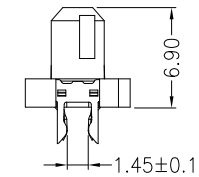
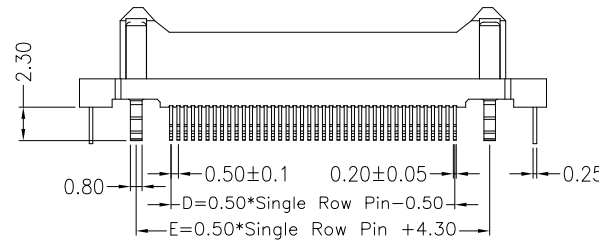
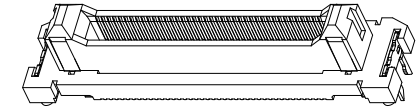
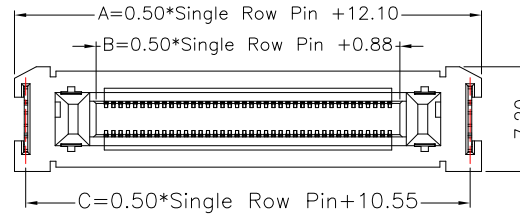

RECOMMENDED PLUG-PCB LAYOUT
TOLERANCE ±0.05

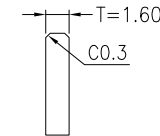

OPERATION		DRAW	WLY	2022.02.17
X.X	±0.40	DESIGN	Jensen	2022.02.17
X.XX	±0.25	CHECK	Jack	2022.02.17
X.XXX	±0.15	APPROVE	Andy	2022.02.17
Angle	±3°	UNIT	mm	SCALE 1:1
DIM.	TOL	UNIT	mm	SCALE 1:1

SOLEPIN 东莞市硕品电子有限公司
Professional connector manufacturer DONGGUAN SOLEPIN ELECTRONICS CO., LTD.

REV	DATE	MODIFICATION DESCRIPTION	CHANGE	APPROVE
AO		NEW		

SIZE	A4	PART NO.	66A2-MXXXXX069R03
SHEET	1/1	TITLE:	0.50mm 浮动BTB 公头 直立夹板式 合高8.0mm TYPE
PROJ.	PROJ.	DRAW NO.	SP-631

客户图

NOTES:

1. FINISH:
 - 1.1 HOUSING: LCP BLACK, UL94V-0.
 - 1.2 CONTACT: COPPER ALLOY, INTEGRAL NICKEL BASE 50u"MIN FLASH GOLD, CONTACT AND SOLDER FOOT AREA 3u"MIN
 - 1.3 GROUND: BRASS, INTEGRAL NICKEL BASE 50u"MIN; FLASH GOLD, CONTACT AND SOLDER FOOT AREA 3u"MIN
2. ELECTRICAL:
 - 2.1 RATED VOLTAGE: SIGNAL PIN AC 50 V.
POWER PIN AC 200 V.
 - 2.1 CURRENT RATING: SIGNAL PIN 0.5A.
POWER PIN 5.0A.
 - 2.2 DIELECTRIC WITHSTANDING VOLTAGE: SIGNAL PIN 150V AC/MINUTE.
POWER PIN 600V AC/MINUTE.
 - 2.3 CONTACT RESISTANCE: SIGNAL PIN 120mΩ MAX.
POWER PIN 80mΩ MAX.
 - 2.4 INSULATION RESISTANCE: SIGNAL PIN 100V DC/0.1S/100MΩ
POWER PIN 250V DC/0.1S/1000MΩ
3. SALT SPRAY TEST:
 - 3.1 CONCENTRATION IS 5%, THE TEMPERATURE IS 35±2°C,
TEST TIME 8H MIN, NO OXIDATION OR RUST
4. MAX PROCESSING TEMP: 265°C SECONDS 40S
5. OPERATION TEMPERATURE: -40°C TO +125°C.
6. WARRANTY PERIOD: 6 MONTHS
7. ORDER INFORMATION:

66A2R-F XXX XX 073 R 01

Pin 数码	端子电镀:	塑胶高度:	包装方式:
SEE TABLE	G0=Gold Flash(全金)	073=7.30mm("H1")	R=TAPE REEL
030=2x15PIN	G1=1u" Gold		
050=2x25PIN	G2=3u" Gold		
.....	G3=5u" Gold		
	G4=10u" Gold		
	G5=15u" Gold		
	G6=30u" Gold		

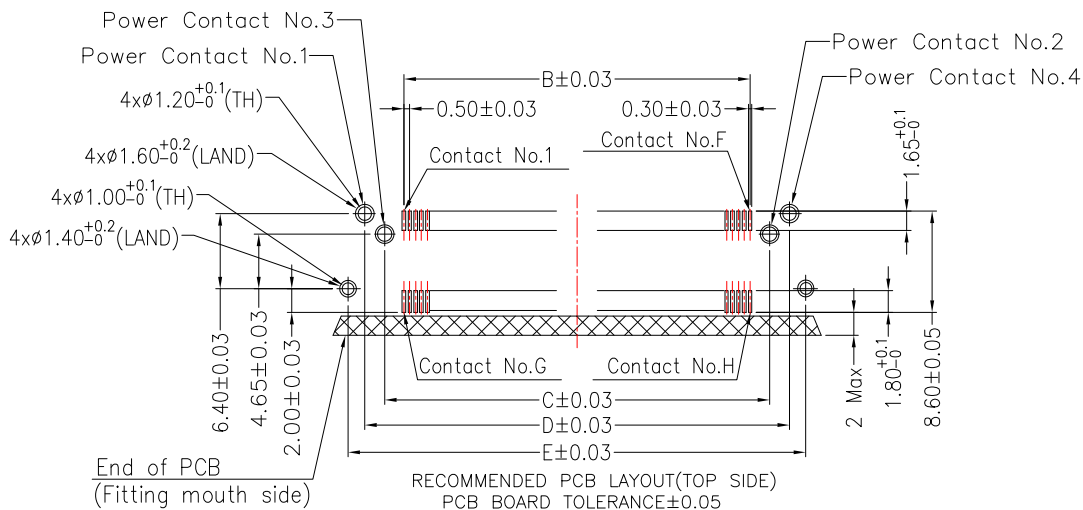
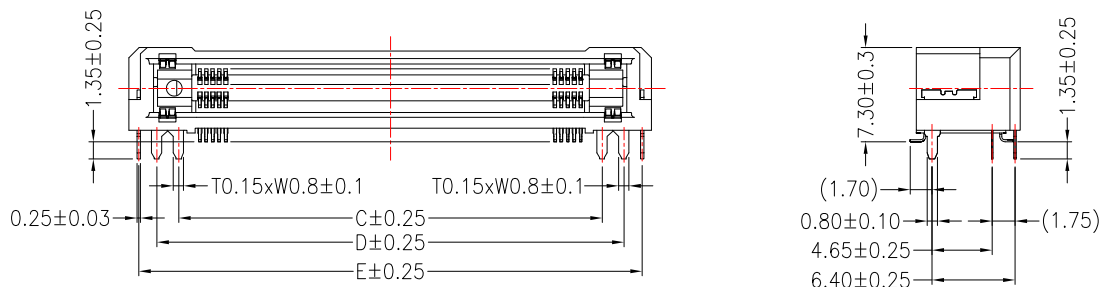
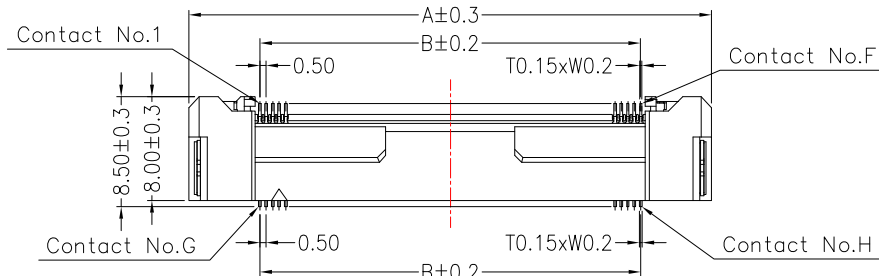

No. OF PIN	A	B	C	D	E
20=2x10PIN	15.50	4.50	7.80	11.20	14.00
30=2x15PIN	18.00	7.00	10.30	13.70	16.50
40=2x20PIN	20.50	9.50	12.80	16.20	19.00
50=2x25PIN	23.00	12.00	15.30	18.70	21.50
60=2x30PIN	25.50	14.50	17.80	21.20	24.00
80=2x40PIN	30.50	19.50	22.80	26.20	29.00
100=2x50PIN	35.50	24.50	27.80	31.20	34.00
120=2x60PIN	40.50	29.50	32.80	36.20	39.00

		OPERATION	DRAW	WLY	2022.04.18	SOLEPIN 东莞市硕品电子有限公司 Professional connector manufacturer DONGGUAN SOLEPIN ELECTRONICS CO., LTD.			
		X.X ±0.40	DESIGN	Jensen	2022.04.18				
		X.XX ±0.25	CHECK	Jack	2022.04.18	SIZE	A4	PART NO.	66A2R-FXXXXX073R01
		X.XXX ±0.15	APPROVE	Andy	2022.04.18	SHEET	1/1	TITLE:	0.50mm 浮动BTB 母座 卧式DIP 90° TYPE
AO	NEW	Angle ±3°	UNIT	mm	SCALE	1:1	PROJ.	DRAW NO.	SP-678
REV	DATE	MODIFICATION DESCRIPTION	CHANGE	APPROVE	DIM.	TOL			