

成品图

NOTES:

1. FINISH:

- 1.1 HOUSING: LCP NATURAL, UL94V-0.
- 1.2 CONTACT: COPPER ALLOY, GOLD (SEE P/N) PLATED IN CONTACT AREA, 50u" MIN. NICKEL UNDERPLATED OVERALL.

2. ELECTRICAL:

- 2.1 CURRENT RATING: 30A/AC POWER PIN (3SET), 100A/DC POWER PIN (2SET).
- 2.2 VOLTAGE RATING: 350V AC POWER PIN, 100V DC POWER PIN.
- 2.3 CONTACT RESISTANCE: 50mΩ MAX
- 2.4 INSULATION RESISTANCE: 100MΩ MIN.
- 3 ELECTRIC CONDUCTIVITY: 85%.
- 4. OPERATION TEMPERATURE: -40°C TO +125°C.

62G1-F 014 NO 360 C 01

Pin数码: 014=14PIN
 端子电镀: NO=Gold Flash/Ni
 塑胶高度: 360=36.0mm
 包装方式: C=TRAY

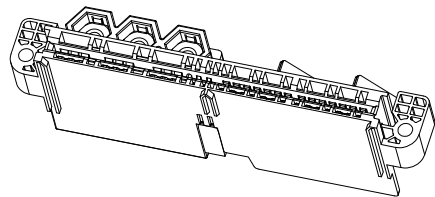

3D VIEW

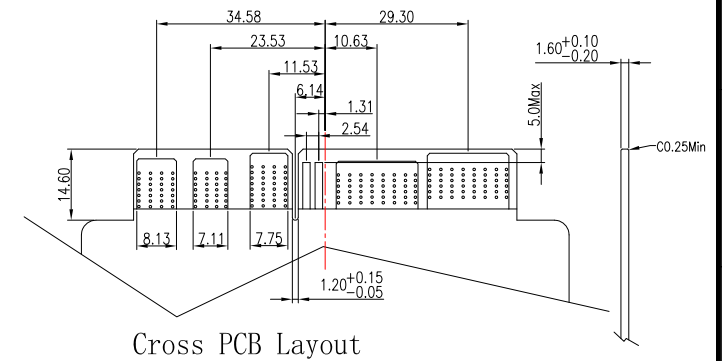
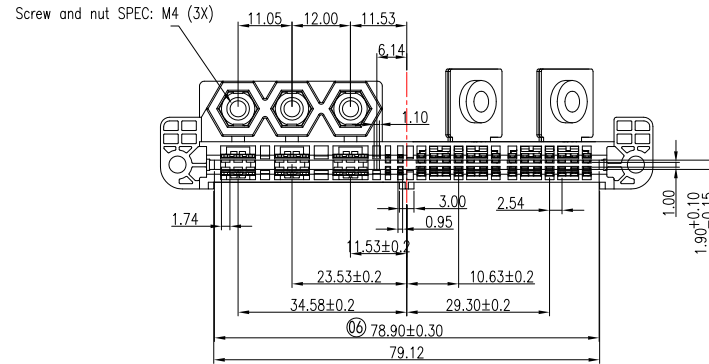
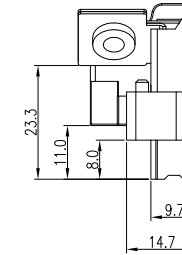
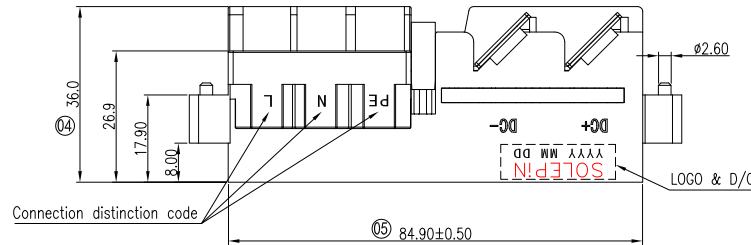
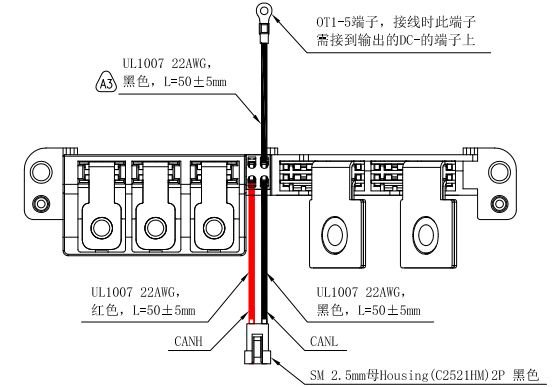
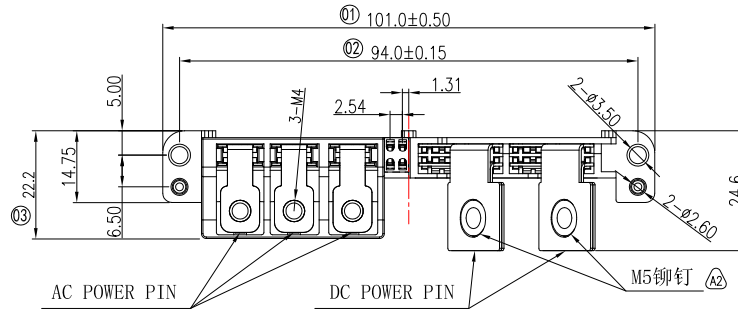

| | | | | | | | | | | | | |
|-----|------------|--------------------------|---------|---------|-------------|---------|--------|------------|----------------------------------------------------------------------------------------------------------|-----|----------|---------------------|
| A3 | 2022.04.08 | OT1-5线材由黄绿相间变更为黑色 | WLY | | OPERATION | DRAW | WLY | 2022.04.08 | SOLEPIN 东莞市硕品电子有限公司 Professional connector manufacturer DONGGUAN SOLEPIN ELECTRONICS CO., LTD. | | | |
| A2 | 2021.02.02 | 铆钉由M4变更为M5 | WLY | | X.X ±0.40 | DESIGN | JENSEN | 2022.04.08 | | | | |
| A1 | 2021.01.06 | 增加铆钉 | WLY | | X.XX ±0.25 | CHECK | JACK | 2022.04.08 | SIZE | A4 | PART NO. | 62G1-F014G2360BC01 |
| A0 | | NEW | CHILLES | ANDY | X.XXX ±0.15 | APPROVE | ANDY | 2022.04.08 | SHEET | 1/1 | TITLE: | POWERMALE-CONNECTOR |
| REV | DATE | MODIFICATION DESCRIPTION | CHANGE | APPROVE | Angle ±3° | | | | PROJ. | ⊙ | DRAW NO. | SP-373 |
| | | | | | DIM. TOL | UNIT | mm | SCALE | 1:1 | | | |

成品图

NOTES:

1. FINISH:
 - 1.1 HOUSING: LCP NATURAL, UL94V-0.
 - 1.2 CONTACT: COPPER ALLOY, GOLD (SEE P/N) PLATED IN CONTACT AREA, 50u" MIN. NICKEL UNDERPLATED OVERALL.
2. ELECTRICAL:
 - 2.1 CURRENT RATING: 30A/AC POWER PIN (3SET).
100A/DC POWER PIN (2SET).
 - 2.2 VOLTAGE RATING: 350V AC POWER PIN.
100V DC POWER PIN.
 - 2.3 CONTACT RESISTANCE: 50mΩ MAX
 - 2.4 INSULATION RESISTANCE: 100MΩ MIN.
3. ELECTRIC CONDUCTIVITY: 85%.
4. OPERATION TEMPERATURE: -40°C TO +125°C.

62G1-F 014 NO 360 C 02

Pin数码: 014=14PIN
端子电镀: NO=Gold Flash/Ni
塑胶高度: 360=36.0mm
包装方式: C=TRAY

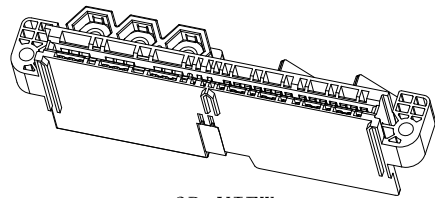
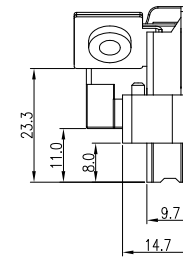
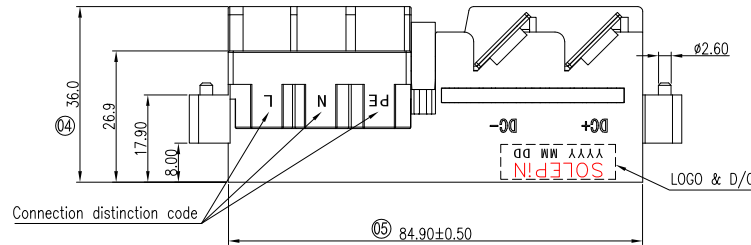
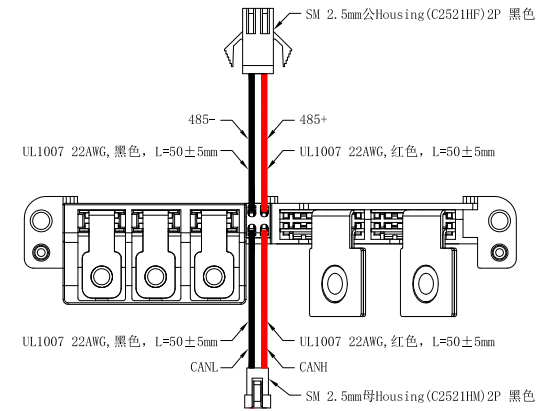
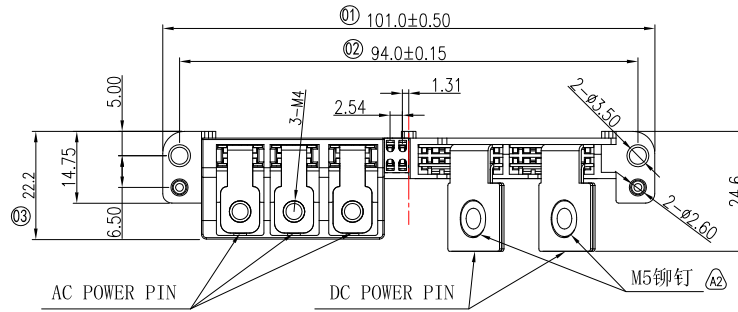

3D VIEW

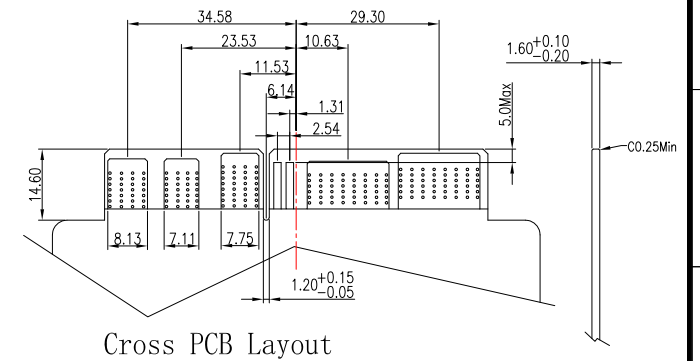
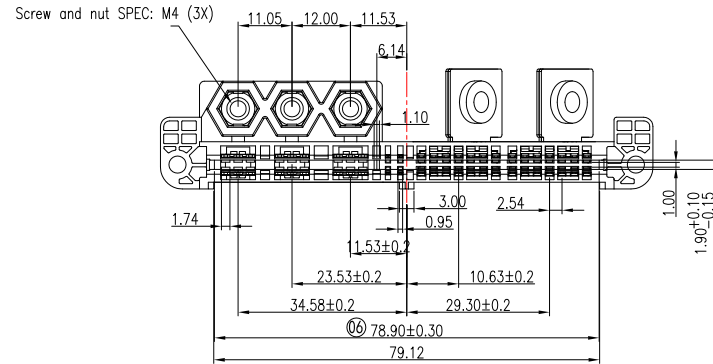

Cross PCB Layout

| REV | DATE | MODIFICATION DESCRIPTION | CHANGE | APPROVE | OPERATION | DRAW | WLY | SCALE | UNIT | mm | SCALE | 1:1 | PROJ. | SIZE | PART NO. | TITLE: | DRAW NO. |
|-----|------------|--------------------------|---------|---------|-------------|---------|--------|------------|------|----|-------|-----|-------|------|----------|--------|----------|
| A2 | 2021.02.02 | 铆钉由M4变更为M5 | WLY | | X.X ±0.40 | DESIGN | JENSEN | 2021.02.02 | | | | | | | | | |
| A1 | 2021.01.06 | 增加铆钉 | WLY | | X.XX ±0.25 | CHECK | JACK | 2021.02.02 | | | | | | | | | |
| AO | | NEW | CHILLES | ANDY | X.XXX ±0.15 | APPROVE | ANDY | 2021.02.02 | | | | | | | | | |
| | | | | | Angle ±3° | | | | | | | | | | | | |
| | | | | | DIM. TOL | | | | | | | | | | | | |
| | | | | | | | | | | | | | | | | | |

SOLEPIN 东莞市硕品电子有限公司
Professional connector manufacturer DONGGUAN SOLEPIN ELECTRONICS CO., LTD.

SIZE: A4 PART NO.: 62G1-F014G2360BC02
SHEET: 1/1 TITLE: POWERFEMALE-CONNECTOR
PROJ. DRAW NO.: SP-347